

Weld Neck Sightglass Fittings Series MV

Application:

Butt-weld sightglass fitting with a threaded cover nut. Sightport for viewing into process vessels, silos, mixers, separators, pipelines, and other usually closed containers. Particularly suitable for pharmaceuticals, food and beverage processing, e.g. breweries, dairies etc.

General:

Sightglass fittings specific to DIN 11851 (dairy standard fittings) with see-through circular glasses. Threaded nozzles have weld necks.

Operating Conditions

Pressure: up to 150 psi (depending on size), vacuum
Temperature: max. 220°C (see temperature diagram) based on seal ring

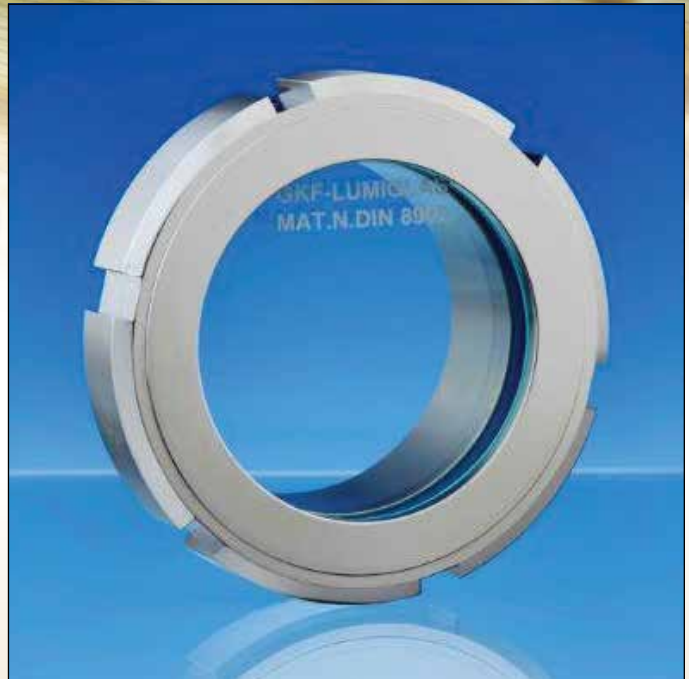
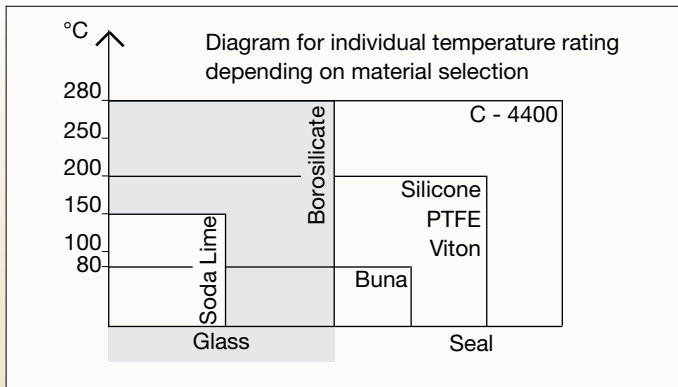

Complete Weld Neck sightglass fitting series MV

Combinations:

This sightglass unit can be combined with the Lumiglas luminaires for use in non hazardous areas. Window wipers, type SW1 can be fitted to sizes DN 65 and larger. Combination of luminaire plus wiper can be fitted to size DN 125.

Parts & materials: (drawing on the right)

Items	Part name	Material options
1	Threaded cover nut	Stainless steel type 304
2	Cushion gasket	Non-Asbestos
3	Sightglass disc	Soda lime glass, tempered for max temp 150°C; or borosilicate glass, tempered for max. temp 280°C
4	D-ring seal	Viton, PTFE, Buna, silicone (max. 250°C)
5	Weld neck nozzle	Stainless steel type: 316 L, 304; ASME material only available upon request
6	Vessel wall	

Assembly

After welding nozzle (5) into the vessel wall (6), fit O-ring seal (4), glass disc (3) and gasket (2) as shown in the drawing on the right. Tighten all these parts down against the nozzle by cover nut (1). Always use the special "C-Spanner".

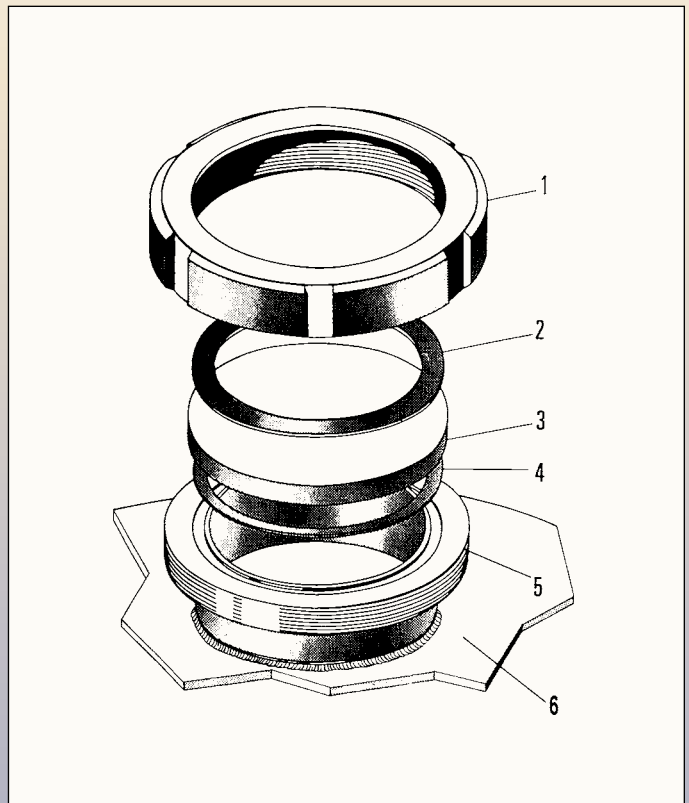

Exploded view of an MV series Weld Neck sightglass fitting

Dimensions of Screwed Sightglass Fittings

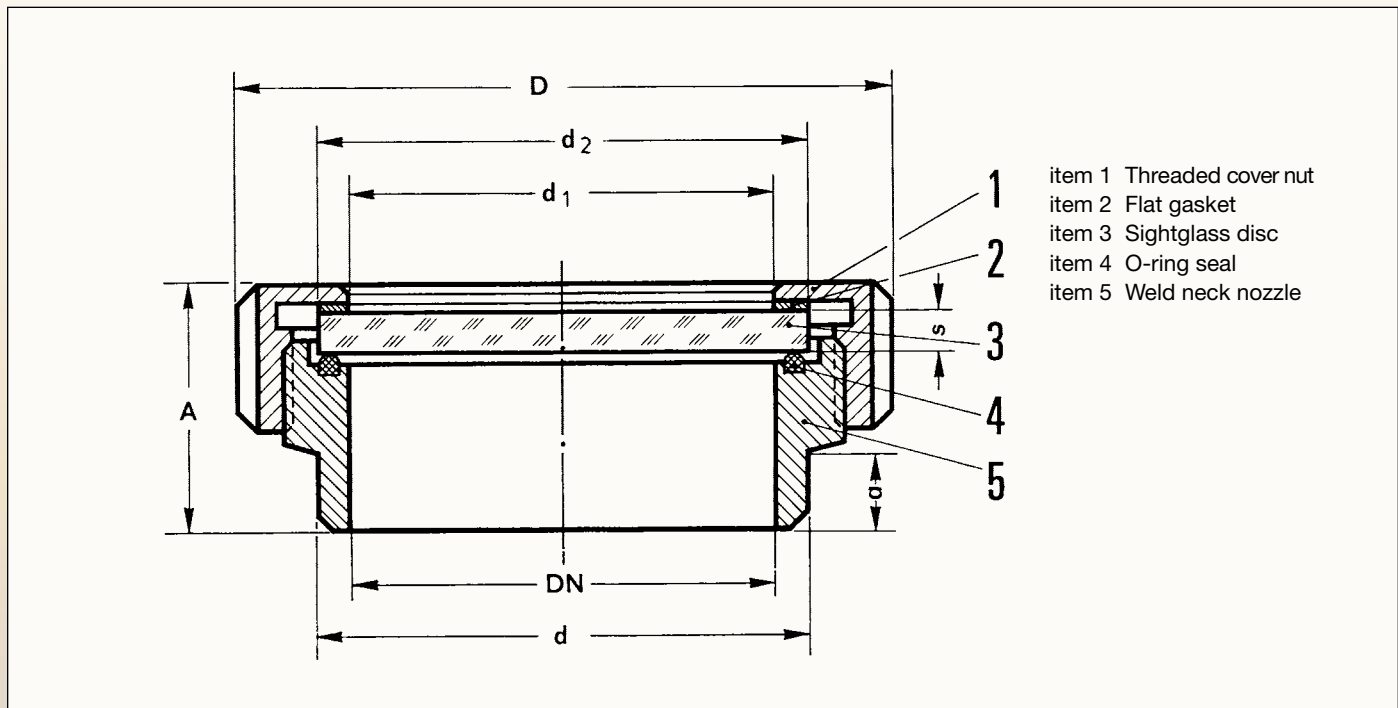

All dimensions in mm unless stated otherwise. Subject to change without prior notice

Size		DN 50	DN 65	DN 80	DN 100	DN 125	DN 150
Nominal bore	DN	50	65	80	100	125	150
Pressure rating (psig)	PN	150	150	150	150	90	90
Viewing diameter	d1*	50 (1.97")	65 (2.56")	80 (3.15")	100 (3.94")	125 (4.92")	150 (5.91")
Sightglass discs	d2	63	80	94	113	142	166
	s	10	12	12	15	15	15
Fittings	D*	92 (3.62")	112 (4.41")	127 (5.00")	148 (5.83")	178 (7.01")	210 (8.27")
	d*	61 (2.40")	79 (3.11")	93 (3.66")	114 (4.49")	136 (5.35")	163 (6.42")
	A*	44 (1.73")	52 (2.05")	57 (2.24")	69 (2.72")	59 (2.32")	62 (2.44")
	a	21	24	25	34	22	22

Ordering Information:

Please specify the selected items as follows:

e.g. Series MV, DN 80, nominal pressure 150 psi

Preferred material for: weld flange, glass discs, seals. Cover nut always 304

* Use mm dimensions for accuracy

ISO 9001 QA CERTIFICATE

GERMAN MANUFACTURER:

F.H. PAPPENMEIER AWARDED QA APPROVAL CERTIFICATE



LJSTAR
INCORPORATED