

Sanitary-Design Fused Glass/Metal Windows For In-Line Process Viewing

Data Sheet 03-0025 10/11



The strongest, most secure glass elements available, Metaglas® mechanically prestressed windows, are now available in a sanitary design for visual flow indicators in processing applications. These units incorporate the USP Class VI biocompatible and BPE compliant Meta-Clamp® sanitary-service sight glasses.

Described as offering the optics of glass and strength of steel, these glass windows provide a level of safety, and a useful service life, well beyond that provided by conventional tempered glass or plastic in sanitary service. Even in the most extreme temperature (to 536°F) or overpressure situations, sudden, total failure, with leakage or explosive shattering of the glass, essentially never occurs.

Patented* Metaglas windows are formed by melting glass, typically borosilicate, into a precisely formed metal ring. As the glass cools, it solidifies and prevents the metal ring from contracting back to its theoretical size at normal temperatures. The result is uniform, mechanically prestressed fusion of glass and metal that combines excellent optical characteristics with greatly enhanced physical characteristics. Also, vital in sanitary service, this high-pressure fusion of glass window and metal ring produces an uninterrupted surface with no open space between the two.

Sanitary visual flow indicators are available in sizes 1/2 inch through 6 inches, in either 316 or 304 stainless steel. Line connections are available in five styles: clamp, orbital weld, flange, bevel seat and I-Line. Gasket options include Buna, EPDM, Viton, PTFE and Silicone, all conforming to USP Class VI and FDA.

For additional information and applications assistance contact:

L.J. Star Incorporated,

P.O. Box 1116, Twinsburg, OH 44087

Phone: (330) 405-3040 • Fax: (330) 405-3070

Web Page: www.ljstar.com • e-mail: view@ljstar.com

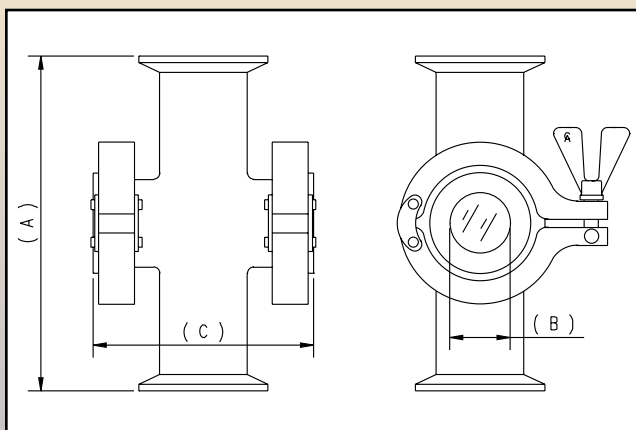

DIMENSIONS (mm/inches)

Tube Size	A	B	C	Wt.(lbs)
1/2"	4.50"	0.39"	2.1"	1.5
3/4"	4.75"	0.39"	2.4"	1.8
1"	5.25"	0.98"	2.8"	2.0
1-1/2"	5.75"	0.98"	3.3"	2.5
2"	6.75"	1.18"	3.8"	3.0
2-1/2"	7.25"	1.38"	4.5"	4.0
3"	7.75"	1.96"	5.0"	4.5
4"	9.50"	2.16"	6.4"	6.0

L.J. STAR
INCORPORATED